



Micro Commercial Components

Micro Commercial Components
 20736 Marilla Street Chatsworth
 CA 91311
 Phone: (818) 701-4933
 Fax: (818) 701-4939

DTC144EKA

NPN Digital Transistors

Features

- Built-in bias resistors enable the configuration of an inverter circuit without connecting external input resistors
- The bias resistors consist of thin-film resistors with complete isolation to allow negative biasing of the input. They also have the advantage of almost completely eliminating parasitic effects.
- Only the on/off conditions need to be set for operation, making device design easy

Absolute maximum ratings @ 25°C

| Symbol | Parameter | Min | Typ | Max | Unit |
|-----------|----------------------|-----|-----|-----|------|
| V_{CC} | Supply voltage | --- | 50 | --- | V |
| V_{IN} | Input voltage | -10 | --- | 40 | V |
| I_O | Output current | --- | 100 | --- | mA |
| P_d | Power dissipation | --- | 200 | --- | mW |
| T_j | Junction temperature | --- | 150 | --- | °C |
| T_{sig} | Storage temperature | -55 | --- | 150 | °C |

Electrical Characteristics @ 25°C

| Symbol | Parameter | Min | Typ | Max | Unit |
|--------------|--|------|-----|------|------------|
| $V_{I(off)}$ | Input voltage ($V_{CC}=5V, I_O=100 \mu A$) | --- | --- | 0.5 | V |
| $V_{I(on)}$ | Input voltage ($V_O=0.3V, I_O=2mA$) | 3.0 | --- | --- | V |
| $V_{O(on)}$ | Output voltage ($I_O/I_I=10mA/0.5mA$) | --- | --- | 0.3 | V |
| I_I | Input current ($V_I=5V$) | --- | --- | 0.18 | mA |
| $I_{O(off)}$ | Output current ($V_{CC}=50V, V_I=0$) | --- | --- | 0.5 | μA |
| G_I | DC current gain ($V_O=5V, I_O=5mA$) | 68 | --- | --- | |
| R_1 | Input resistance | 32.9 | 47 | 61.1 | K Ω |
| R_2/R_1 | Resistance ratio | 0.8 | 1.0 | 1.2 | |
| f_T | Transition frequency ($V_{CE}=10V, I_E=5mA, f=100MHz$) | --- | 250 | --- | MHz |

Equivalent circuit

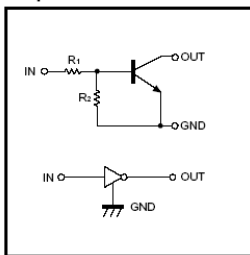

SOT-23-3L

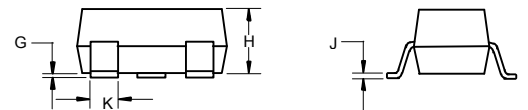
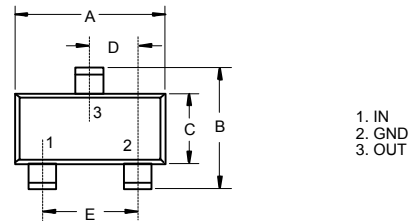

| DIM | INCHES | | MM | | NOTE |
|-----|--------|-------|------|------|------|
| | MIN | MAX | MIN | MAX | |
| A | .113 | .117 | 2.87 | 2.97 | |
| B | .108 | .112 | 2.75 | 2.85 | |
| C | .061 | .065 | 1.55 | 1.65 | |
| D | .036 | .038 | .925 | .975 | |
| E | .073 | .077 | 1.85 | 1.95 | |
| G | .0016 | .0039 | .04 | .100 | |
| H | .044 | .049 | 1.12 | 1.25 | |
| J | .006 | .007 | .14 | .17 | |
| K | .013 | .015 | .34 | .37 | |

Suggested Solder Pad Layout

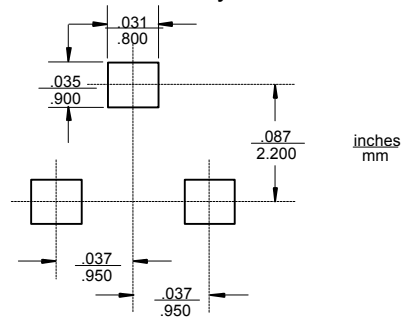

DTC144EKA



Micro Commercial Components

● Electrical characteristic curves

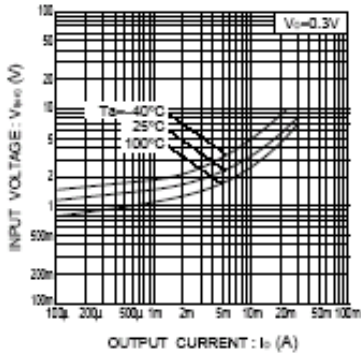

Fig.1 Input voltage vs. output current (ON characteristics)

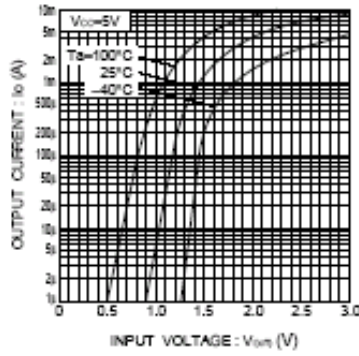

Fig.2 Output current vs. input voltage (OFF characteristics)

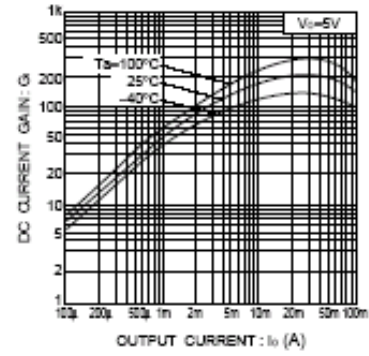

Fig.3 DC current gain vs. output current

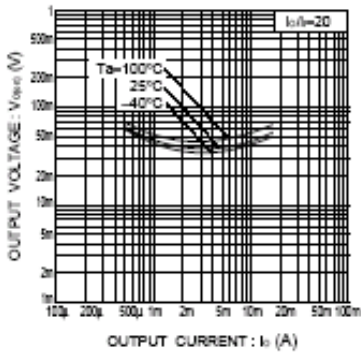

Fig.4 Output voltage vs. output current